

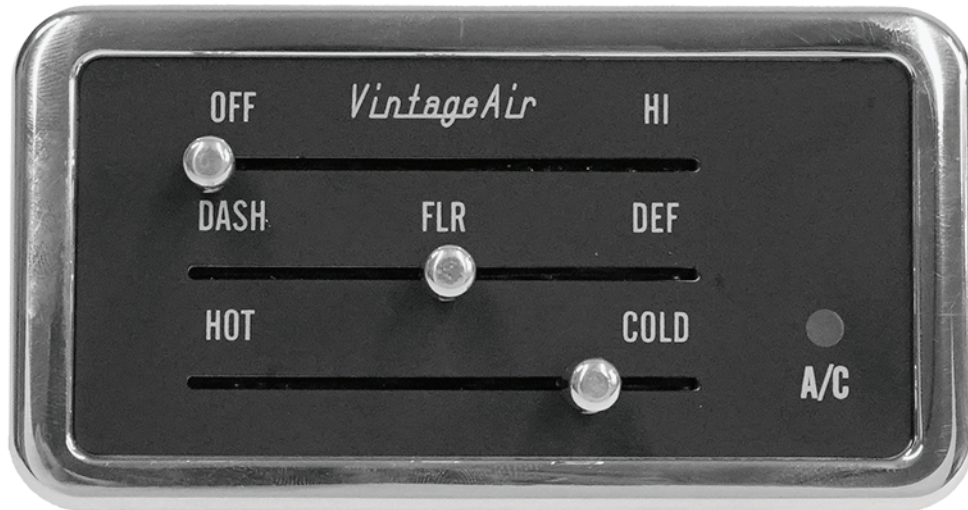

ProLine

Horizontal Control Panel Kit
Polished (490765)
Black Anodized (490769)
Clear Anodized (490772)



18865 Goll St. San Antonio, TX 78266
Phone: 800-862-6658
Sales: sales@vintageair.com
Tech Support: tech@vintageair.com
www.vintageair.com



www.vintageair.com

Table of Contents

Cover..... 1

Table of Contents..... 2

Packing List/Parts Disclaimer..... 3

Dash Modification..... 4

Control Panel Installation..... 5

Gen IV Wiring Diagram..... 6

Gen 5 Wiring Diagram..... 7

Operation of Controls..... 8

Packing List..... 9

Important Notice—Please Read

- **This control panel is designed to work with a Gen IV evaporator unit equipped with a 246204-PUA ECU (all ECU's on Gen 5 evaporators will work with this control). Please confirm that your unit has the proper ECU prior to installing the control panel as shown below. A replacement ECU can be purchased from Vintage Air if needed.**
- **This panel was designed to retrofit any vehicle's previously equipped with the following Gen II controls: 49110-SHQ & 48103-SHQ.**
- **A template has also been provided to cut a new opening if not previously equipped (See Page 4).**



www.vintageair.com

Packing List: Control Panel Kit (490765)

No.	Qty.	Part No.	Description
1.	1	232007-VUR	Control Harness, Gen IV/Gen 5 Universal
2.	1	490766	Control Panel Assembly, Polished

**** Before beginning installation, open all packages and check contents of shipment. Please report any shortages directly to Vintage Air within 15 days. After 15 days, Vintage Air will not be responsible for missing or damaged items.**

1



2



Control Panel Kit (490769)

No.	Qty.	Part No.	Description
1.	1	232007-VUR	Control Harness, Gen IV/Gen 5 Universal
2.	1	490770	Control Panel Assembly, Black Anodized

**** Before beginning installation, open all packages and check contents of shipment. Please report any shortages directly to Vintage Air within 15 days. After 15 days, Vintage Air will not be responsible for missing or damaged items.**

1



2



Control Panel Kit (490772)

No.	Qty.	Part No.	Description
1.	1	232007-VUR	Control Harness, Gen IV/Gen 5 Universal
2.	1	490773	Control Panel Assembly, Clear Anodized

**** Before beginning installation, open all packages and check contents of shipment. Please report any shortages directly to Vintage Air within 15 days. After 15 days, Vintage Air will not be responsible for missing or damaged items.**

1



2



NOTE: Images may not depict actual parts and quantities. Refer to packing list for actual parts and quantities.



www.vintageair.com

Dash Modification

1. Mask the area 3" (tall) x 5" (wide).
2. Place and level the template onto the dash to cut out the opening.

WARNING! THIS OPENING MUST BE A PRECISE FIT. CUT OPENING UNDER SIZE, THEN FILE TO FIT. IF THE OPENING IS OVERSIZED, THE PANEL MAY SHIFT DURING USE.

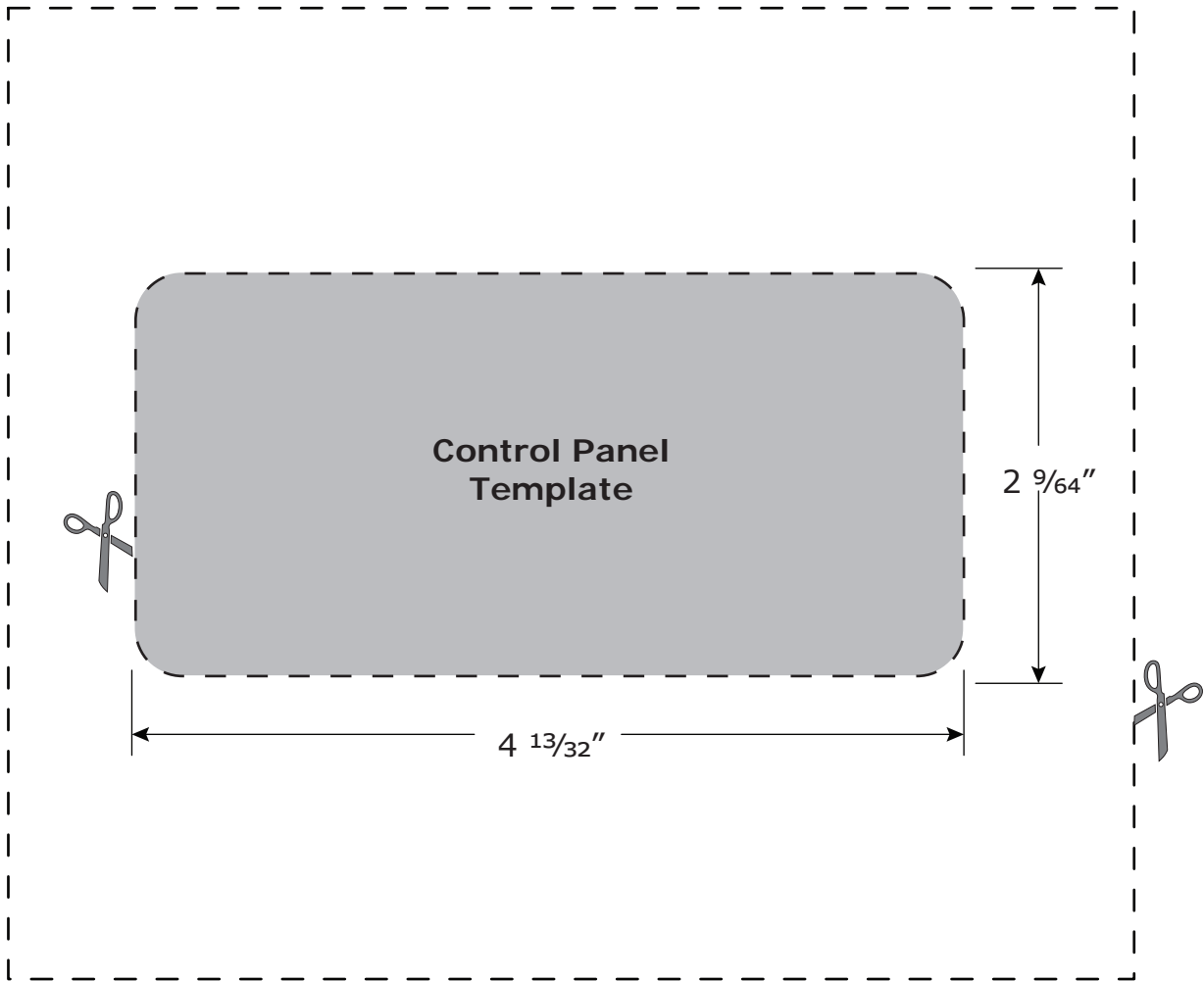

WARNING! THIS OPENING MUST BE A PRECISE FIT. CUT OPENING UNDERSIZE, THEN FILE TO FIT. IF THE OPENING IS OVERSIZED, THE PANEL MAY SHIFT DURING USE.

NOTE: Due to printing variances, measure the line below before using this template. If template is scaled properly, the line should measure 6 inches.

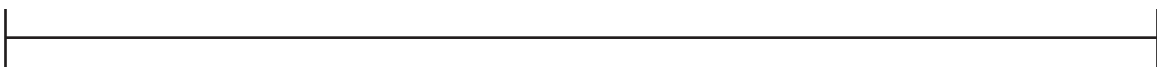



www.vintageair.com

Control Panel Installation

1. Install the 3-lever panel assembly into the dash by placing the control panel bracket behind the dash and securing it to the 3-lever panel assembly using a 10-24 nylon locknut (See Figure 1, below).
2. Plug the control panel wiring harness into the 3-lever panel assembly and the ECU on the evaporator unit as shown in Figure 2, below.
3. Wire according to the wiring diagram on Page 6 for Gen IV systems or Page 7 for Gen 5 systems.

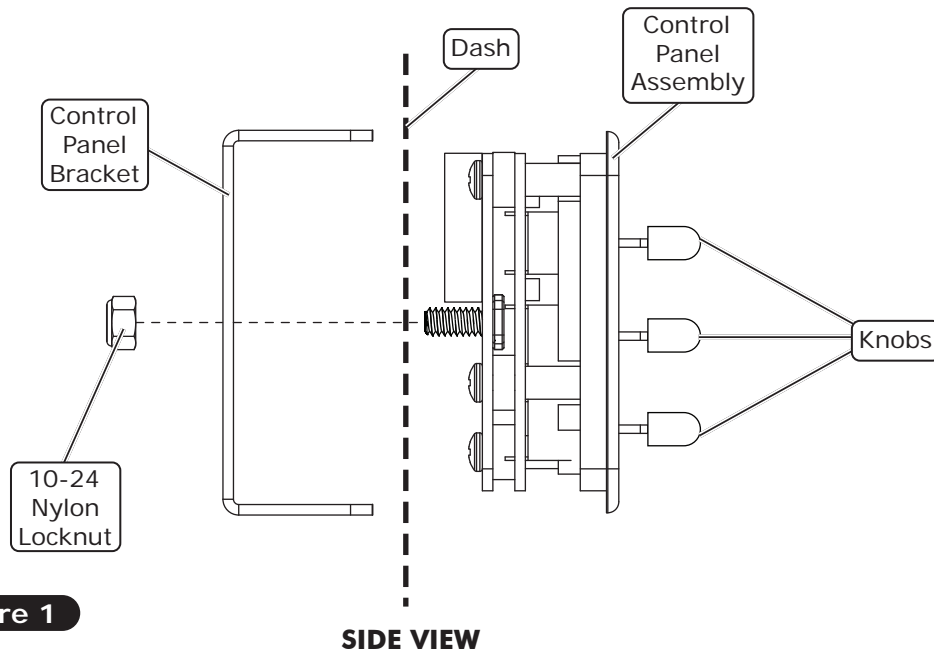

NOTE: When using a Vintage Air supplied control panel, connect the TAN 20 AWG wire from the Gen IV evaporator wiring harness (232010) or the Gen 5 evaporator wiring harness (231505) to the factory dash lights to enable panel backlighting.

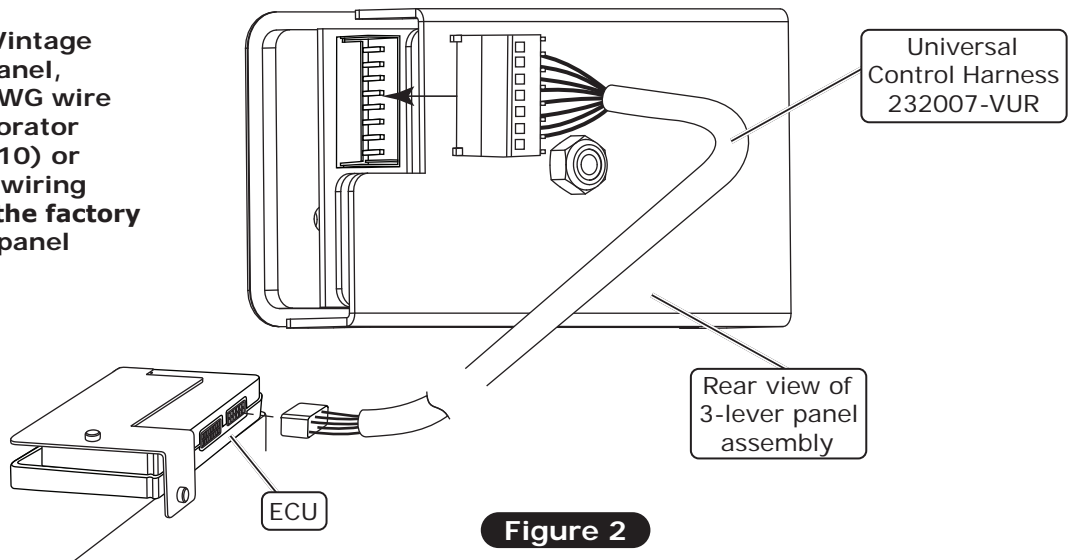



www.vintageair.com

Gen IV Wiring Diagram

232007-VUR

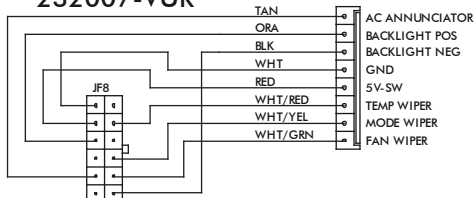

VIEWED FROM WIRE SIDE

232002-VUA

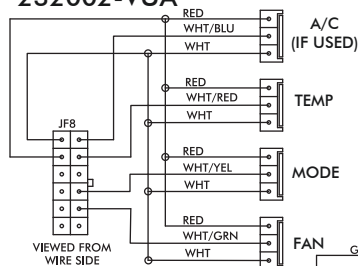

VIEWED FROM WIRE SIDE

PROGRAM

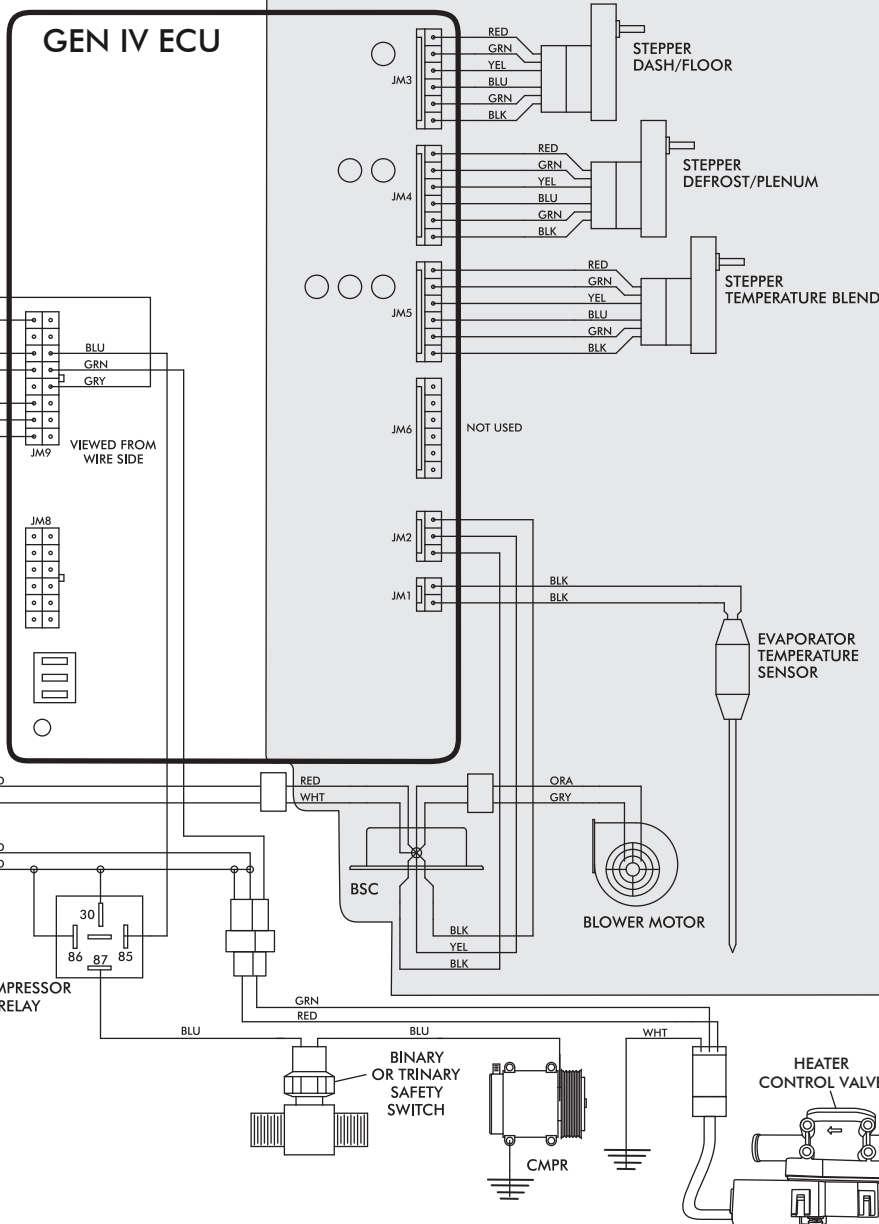
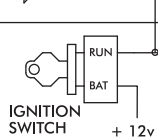
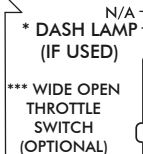

NOTE: = CHASSIS GROUND

* Dash lamp is used only with type 232007-VUR harness.

** Warning: Always mount circuit breaker as close to the battery as possible. (NOTE: Wire between battery and circuit breaker is unprotected and should be carefully routed to avoid a short circuit).

*** Wide open throttle switch contacts close only at full throttle, which disables A/C compressor.



www.vintageair.com

Gen 5 Wiring Diagram

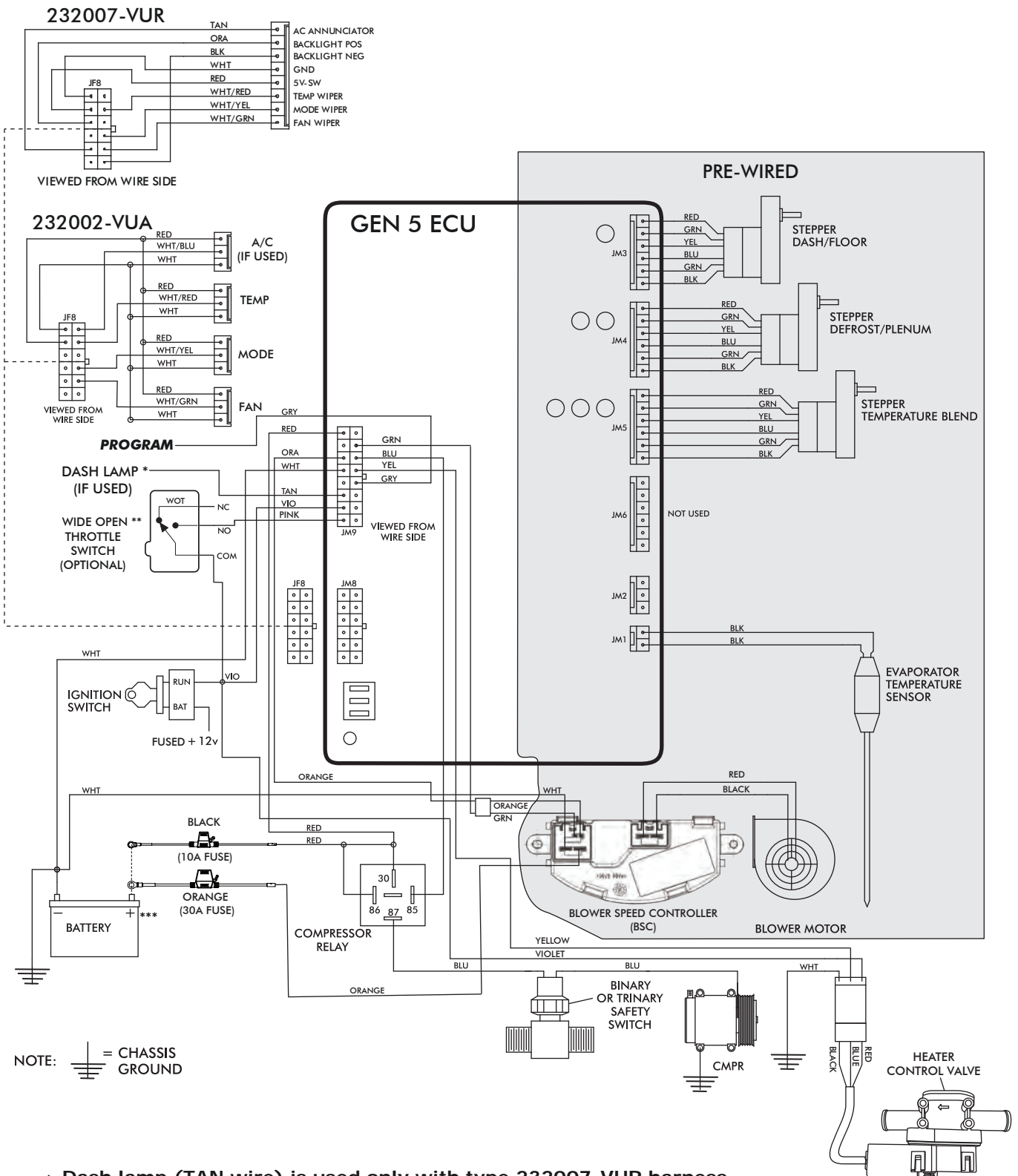

NOTE: = CHASSIS GROUND

- * Dash lamp (TAN wire) is used only with type 232007-VUR harness.
- ** Wide open throttle switch contacts close only at full throttle, which disables A/C compressor.
- *** Install fuse assemblies at or as near to the battery as possible.



www.vintageair.com

Operation of Controls

On Gen IV and Gen 5 systems with three lever/knob controls, the temperature control toggles between heat and A/C operations. To activate A/C, move the temperature lever/knob all the way to cold and then back it off to the desired vent temperature. For heat operation, move the temperature lever/knob all the way to hot and then adjust to the desired vent temperature. The blower will momentarily change speed, each time you toggle in and out of heat and A/C operations, to indicate the change.

Blower Speed

This lever/knob controls blower speed, from OFF to HI.

Mode Control

This lever/knob controls the mode positions, from DASH to FLOOR to DEFROST, with a blend in between.

Temperature Control

This lever/knob controls the temperature, from HOT to COLD.

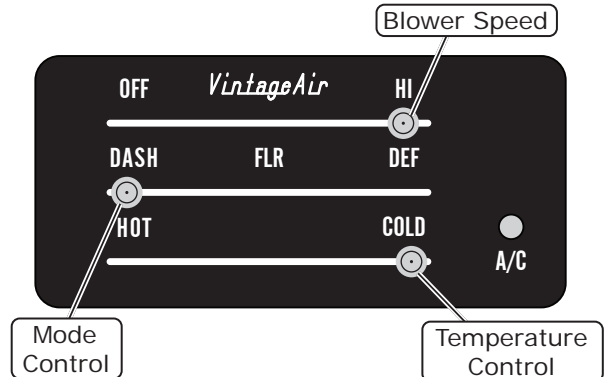

A/C Operation

Blower Speed

Adjust to desired speed.

Mode Control

Adjust to desired mode position (DASH position recommended).

Temperature Control

For A/C operation, adjust to coldest position to engage compressor (Adjust between HOT and COLD to reach desired temperature).

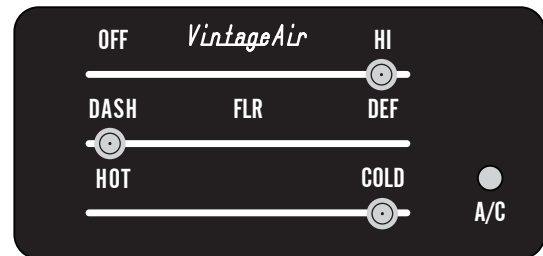

Heat Operation

Blower Speed

Adjust to desired speed.

Mode Control

Adjust to desired mode position (FLOOR position recommended).

Temperature Control

For maximum heating, adjust to hottest position (Adjust between HOT and COLD to reach desired temperature).



Defrost/De-fog Operation

Blower Speed

Adjust to desired speed.

Temperature Control

Adjust to desired temperature.

Mode Control

Adjust to DEFROST position for maximum defrost, or between FLOOR and DEFROST positions for a bi-level blend (Compressor is automatically engaged).

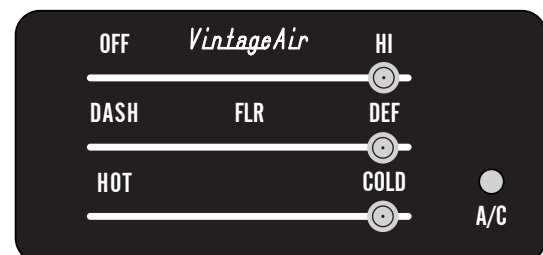



www.vintageair.com

Packing List: Control Panel Kit (490765)

No.	Qty.	Part No.	Description
1.	1	232007-VUR	Control Harness, Gen IV/Gen 5 Universal
2.	1	490766	Control Panel Assembly, Polished

Checked By: _____
Packed By: _____
Date: _____

1



2



Control Panel Kit (490769)

No.	Qty.	Part No.	Description
1.	1	232007-VUR	Control Harness, Gen IV/Gen 5 Universal
2.	1	490770	Control Panel Assembly, Black Anodized

Checked By: _____
Packed By: _____
Date: _____

1



2



Control Panel Kit (490772)

No.	Qty.	Part No.	Description
1.	1	232007-VUR	Control Harness, Gen IV/Gen 5 Universal
2.	1	490773	Control Panel Assembly, Clear Anodized

Checked By: _____
Packed By: _____
Date: _____

1



2



**NOTE: Images may not depict actual parts and quantities.
Refer to packing list for actual parts and quantities.**